

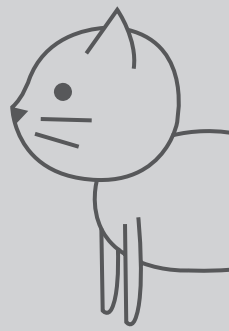

KERBL Pet

#84466



- | | | | | | |
|-----------------|----------------|-----|----------------|----------------|----------------|
| 1 | 2 | 3 | A | B | C |
| | | | | | |
| M8*40mm
2PCS | M8*80mm
1PC | 1PC | D8*41cm
1pc | D8*37cm
1pc | D8*37cm
1pc |

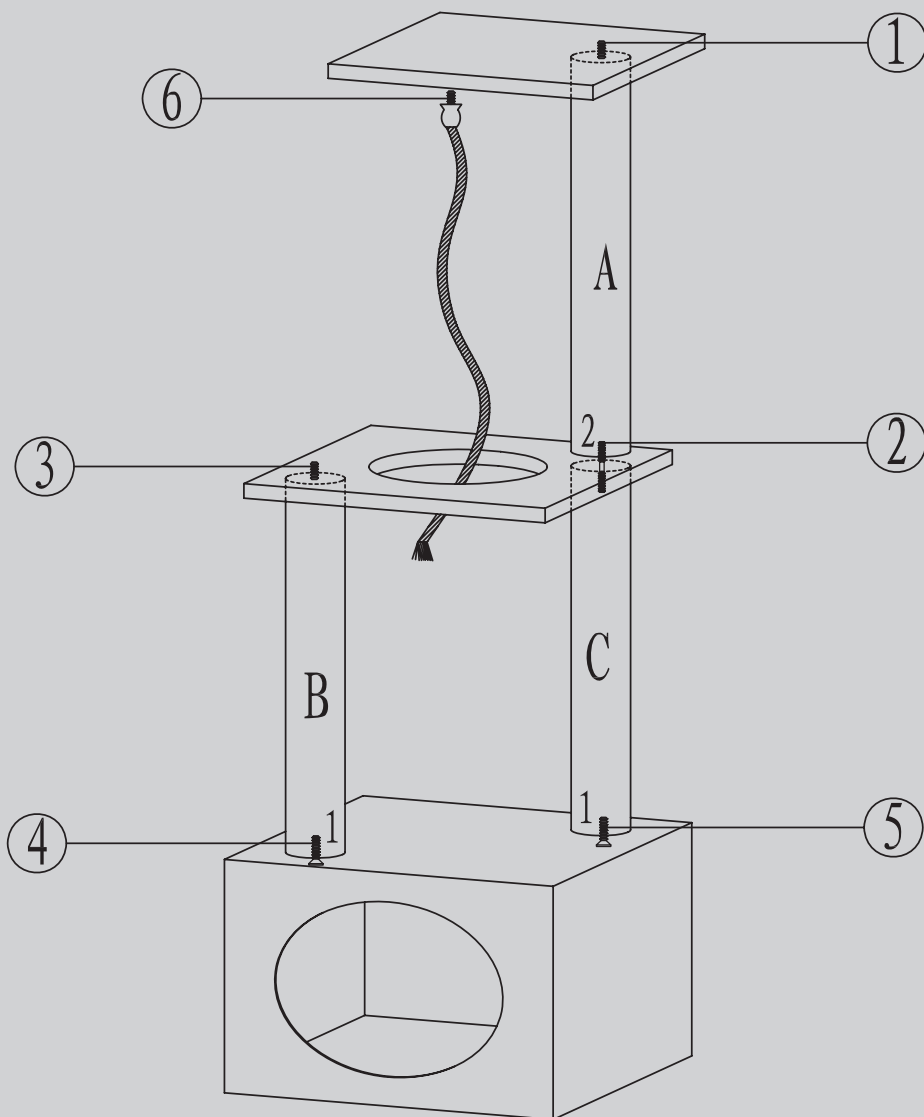

(DE) Bitte halten Sie die Reihenfolge der Arbeitsschritte 1,2,3,... von der Skizze ein.
 (FR) Veuillez suivre la sequence du Workflow 1, 2, 3 ...comme vous pouvez le voir sur le schema.
 (EN) Pls follow the sequence of the workflow 1,2,3,... as you can see on the draft.

Albert Kerbl GmbH
 Felizenzell 9
 84428 Buchbach, Germany
 Tel. +49 8086 933 - 100
 Fax +49 8086 933 - 500
 E-Mail info@kerbl.de
 www.kerbl.de

Kerbl Austria Handels GmbH
 Wirtschaftspark 1
 9130 Poggersdorf
 Tel. +43 4224 81555
 Fax. +43 4224 81555-629
 E-Mail order@kerbl-austria.at
 www.kerbl-austria.at

Kerbl France Sarl
 3 rue Henri Rouby, B.P 46 Soultz
 68501 Guebwiller Cedex, France
 Tel. +33 3 89 62 15 00
 Fax +33 3 89 83 04 46
 E-Mail info@kerbl-france.com
 www.kerbl-france.com

Kerbl UK Limited
 8 Lands End Way
 Oakham, Rutland
 LE15 6RF UK
 Phone +44 01572 722558
 Fax +44 01572 757614
 E-Mail enquiries@kerbl.co.uk
 www.kerbl.co.uk